

## #UP1008

### Miniskirt

This miniskirt features a classic design with a front slit and back zipper closure for easy wear. The tailored silhouette flatters your figure with back darts for contouring. Sew it in a sleek faux leather or suede.

**1 cm seam allowance included!**

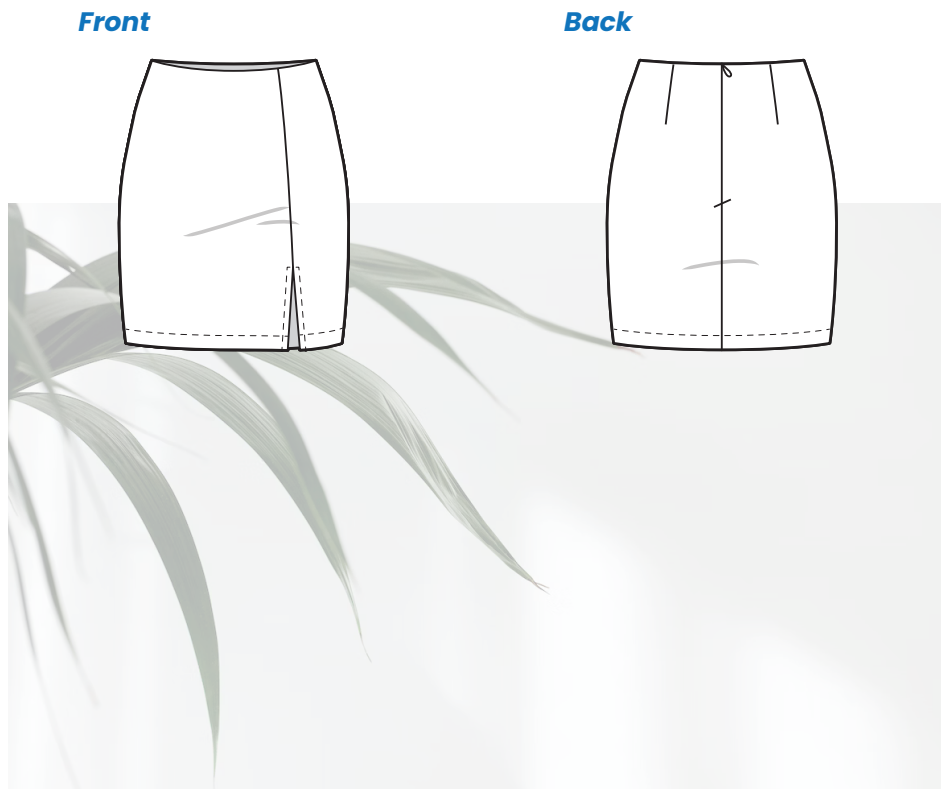

#### Material

- 75 x 150 cm of faux leather or suede with soft backing
- 20 x 90 cm of light fusible interfacing
- All-purpose thread
- Leather needle
- Teflon foot
- 1x invisible zipper (length 20 cm)
- Invisible zipper foot

#### Print & Assemble

- First, be sure to use ACROBAT READER to open your PDF sewing patterns. It's free!
- Then, open your file and click on the LAYERS icon (left side of the screen) and uncheck all the sizes you won't need.
- Now, click on the PRINT icon at the top of the screen. The print settings will appear, so verify that the ACTUAL SIZE option is checked. Click on the PRINT button!
- A 5 x 5 cm (and 2 x 2") control square is provided to ensure that your pattern is true to size.
- To ASSEMBLE, cut the sheets at the bottom and right margins, as indicated. Each sheet is labelled with a letter and a number (A1, B2...), so tape them together in numerical and alphabetical order. The sheets on one row should have the same letter, and the ones on the same column should have the same number.

#### Sizing Guide

	XXS	XS	S	M	L	XL	XXL
<b>Bust</b>	85 cm	89 cm	93 cm	99 cm	105 cm	113 cm	121 cm
<b>Waist</b>	64 cm	68 cm	72 cm	78 cm	84 cm	92 cm	100 cm
<b>Hips</b>	92 cm	96 cm	100 cm	106 cm	112 cm	120 cm	128 cm

This pattern is drafted according to a standard height of **1.64 m**.

#### Garment measurements

- **Length:** 44 cm

## #UP1008

### Miniskirt

---

#### Pattern Pieces

- Back, 2x fabric
- Front, 1x fabric
- Side front, 1x fabric
- Frt facing, 1x fabric 1x interfacing
- Bk facing, 2x fabric 2x interfacing

#### Sewing Assembly

Unless otherwise specified, sew using a **1 cm** wide seam allowance.

1. Fuse the facing pieces on medium heat. **\*\*Protect the fabric with a pressing cloth between the iron and the interfacing.**
2. Sew the back darts.
3. Sew the centre back seam (bottom to marking). Press open.
4. Attach the invisible zipper.
5. Sew the front pieces (waist to marking).
6. Sew the slit.
7. Sew the front and back panels at the side seams.
8. Sew the facings at the side seams.
9. Attach the facing to the waist. Under stitch the waist seam and fold the facing inside the garment.
10. Hem the bottom of the skirt (turn once 3 cm).



Share a photo of you  
wearing proudly  
your new miniskirt  
with

**#unfetteredpatterns!**



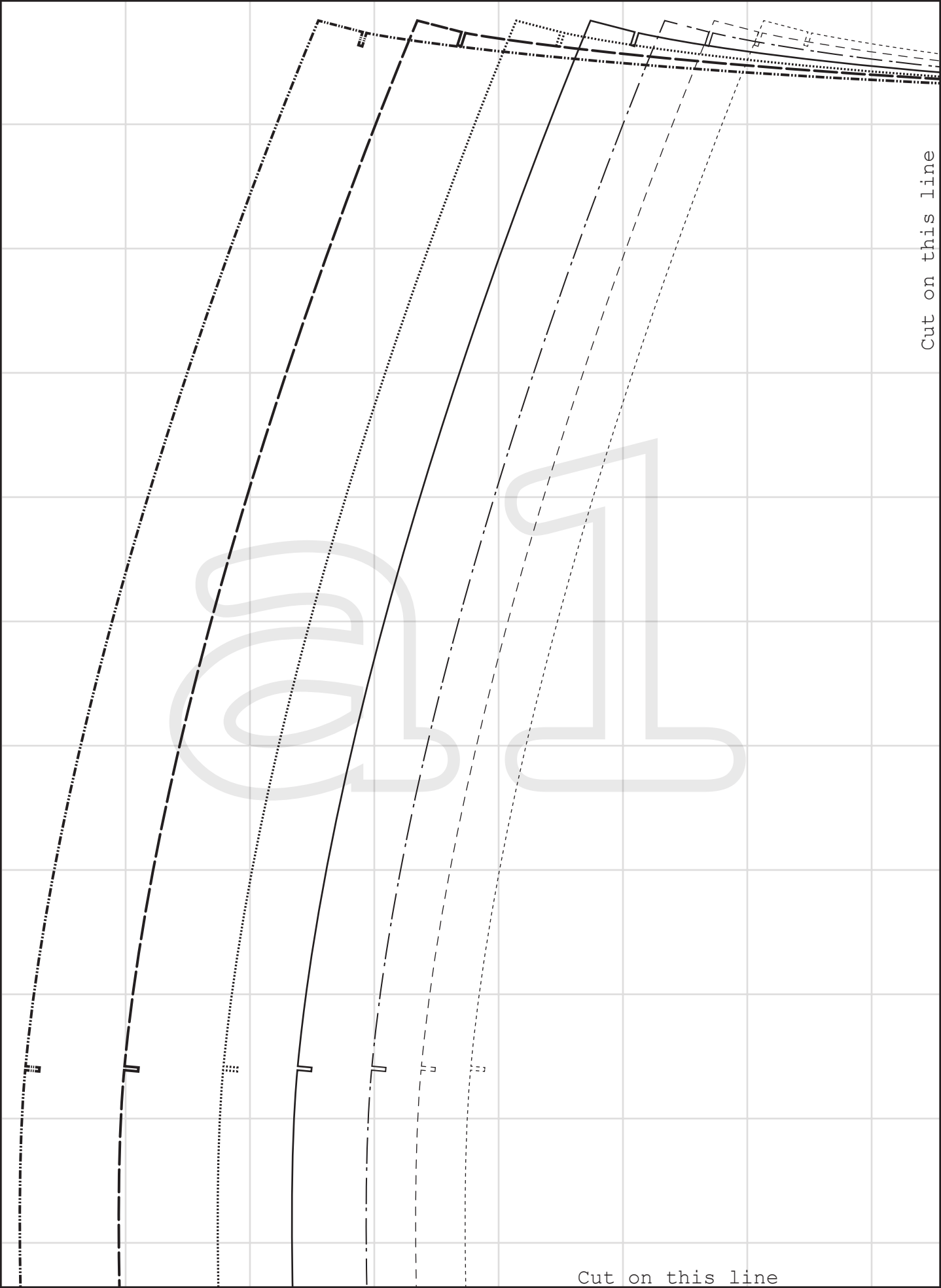

Cut on this line

Cut on this line

Cut on this line



**unfettered**  
— unfettered patterns —

[unfetteredpatterns.wordpress.com](http://unfetteredpatterns.wordpress.com)

Model **#UP1008**

Sizes **XXS-XXL**

**Front**

Cut x1 fabric \*\* RIGHT SIDE UP

Cut on this line

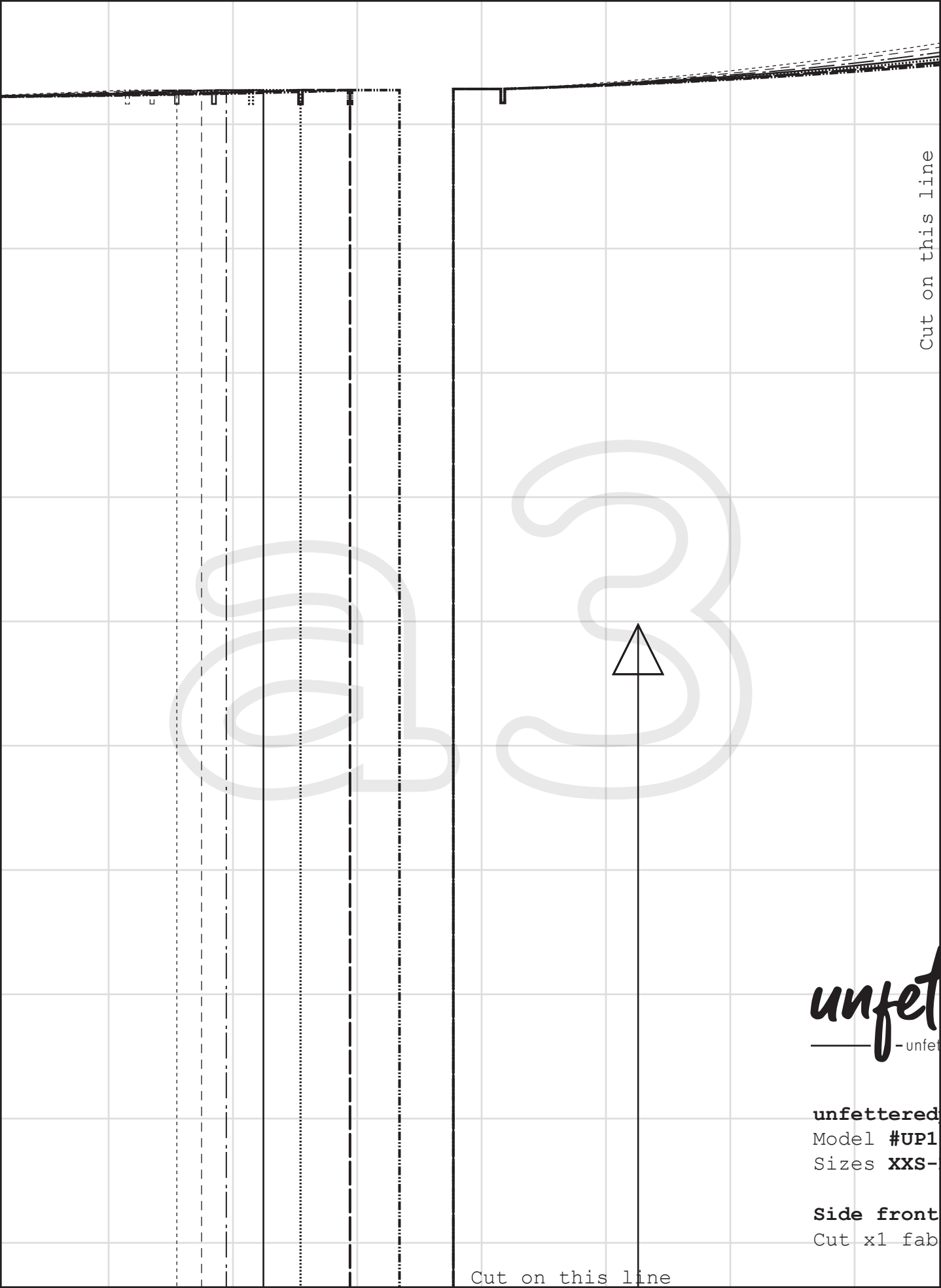

Cut on this line



Cut on this line

**unfettered**  
-unfettered

**unfettered**  
Model #UP1  
Sizes **XXS-**

**Side front**  
Cut x1 fab

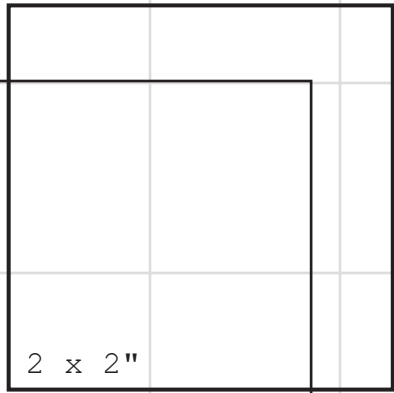
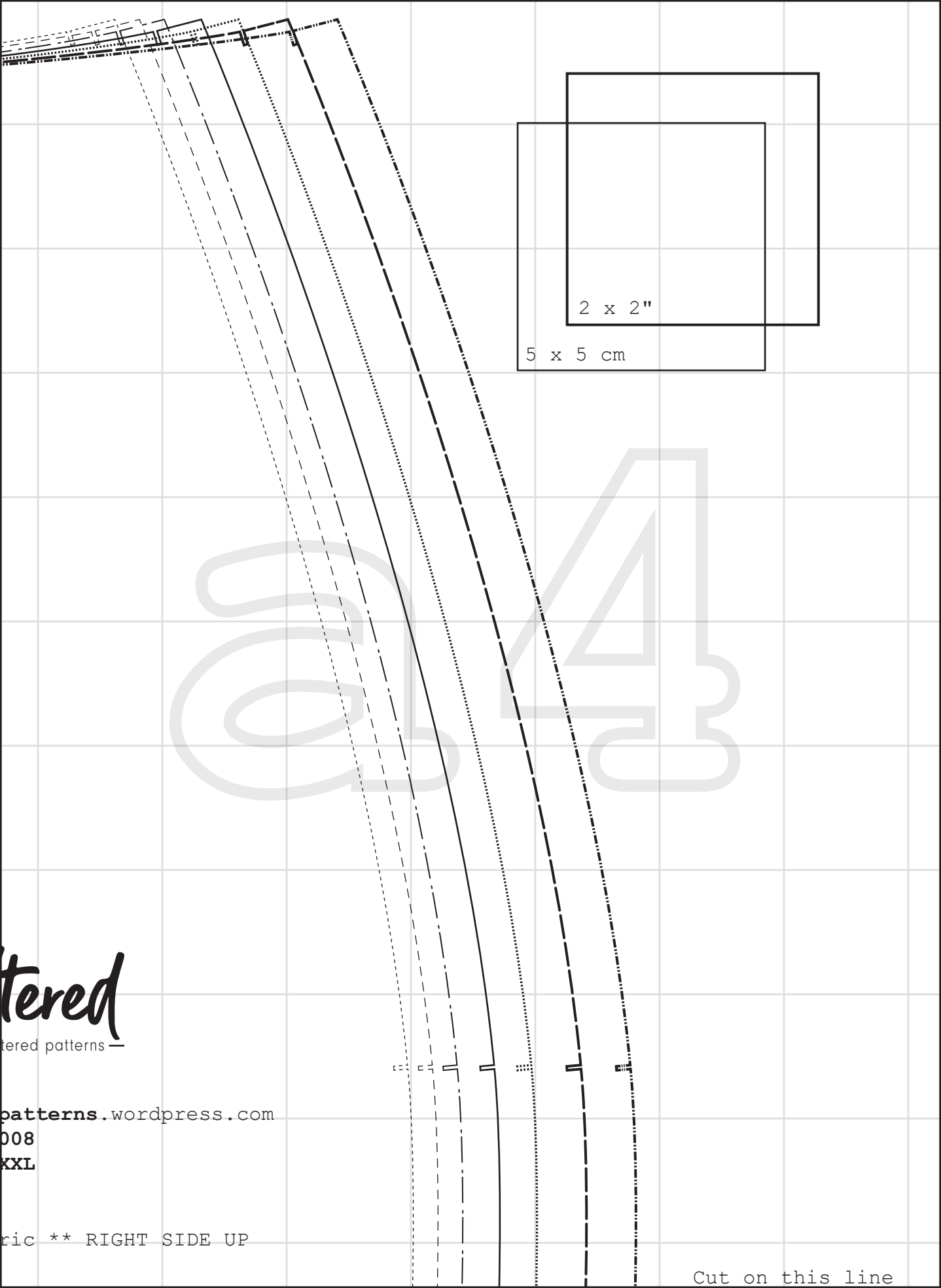

2 x 2"

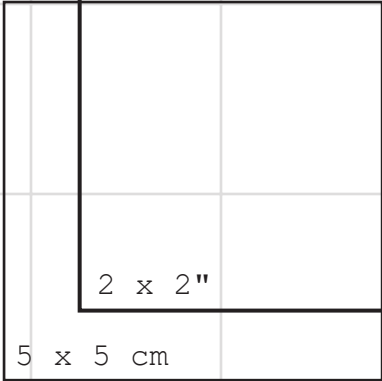

5 x 5 cm

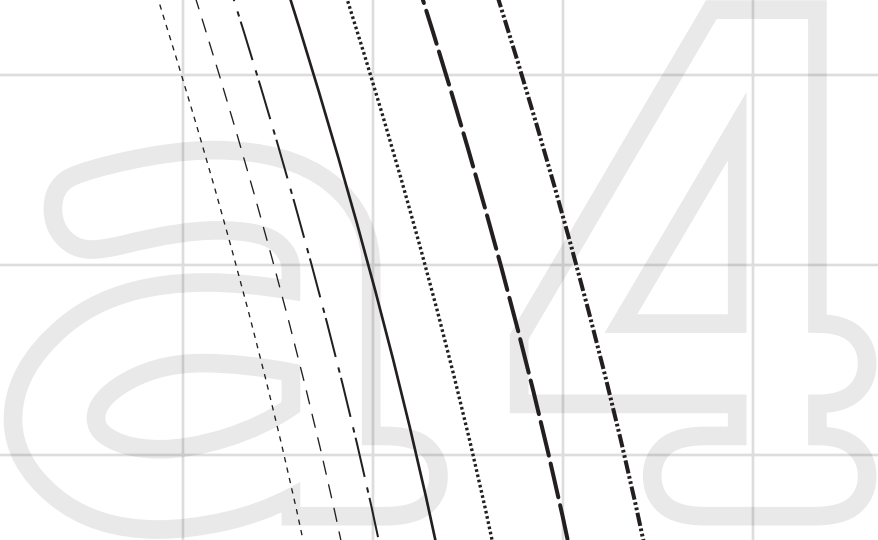

tered

tered patterns —

patterns.wordpress.com

008

XXL

ric \*\* RIGHT SIDE UP

Cut on this line

SIZE

XXL

XL

L

M

S

XS

XXS

Cut on this line

H

Cut on this line

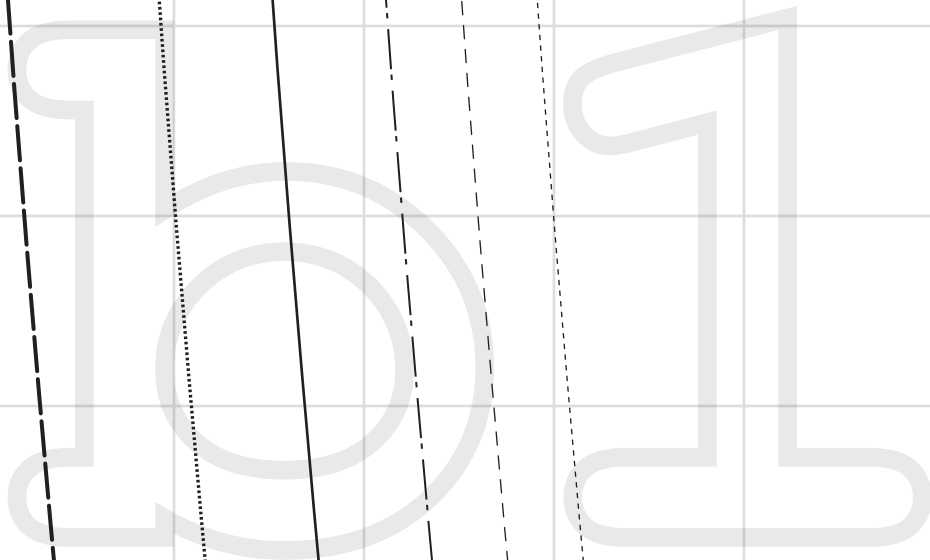

KEY

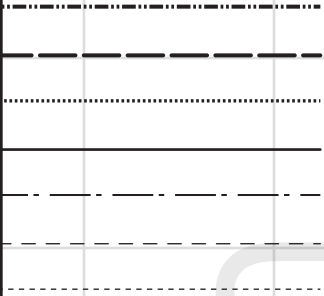

Grainline

Cut on this line

em allowance 3 cm

Cut on this line



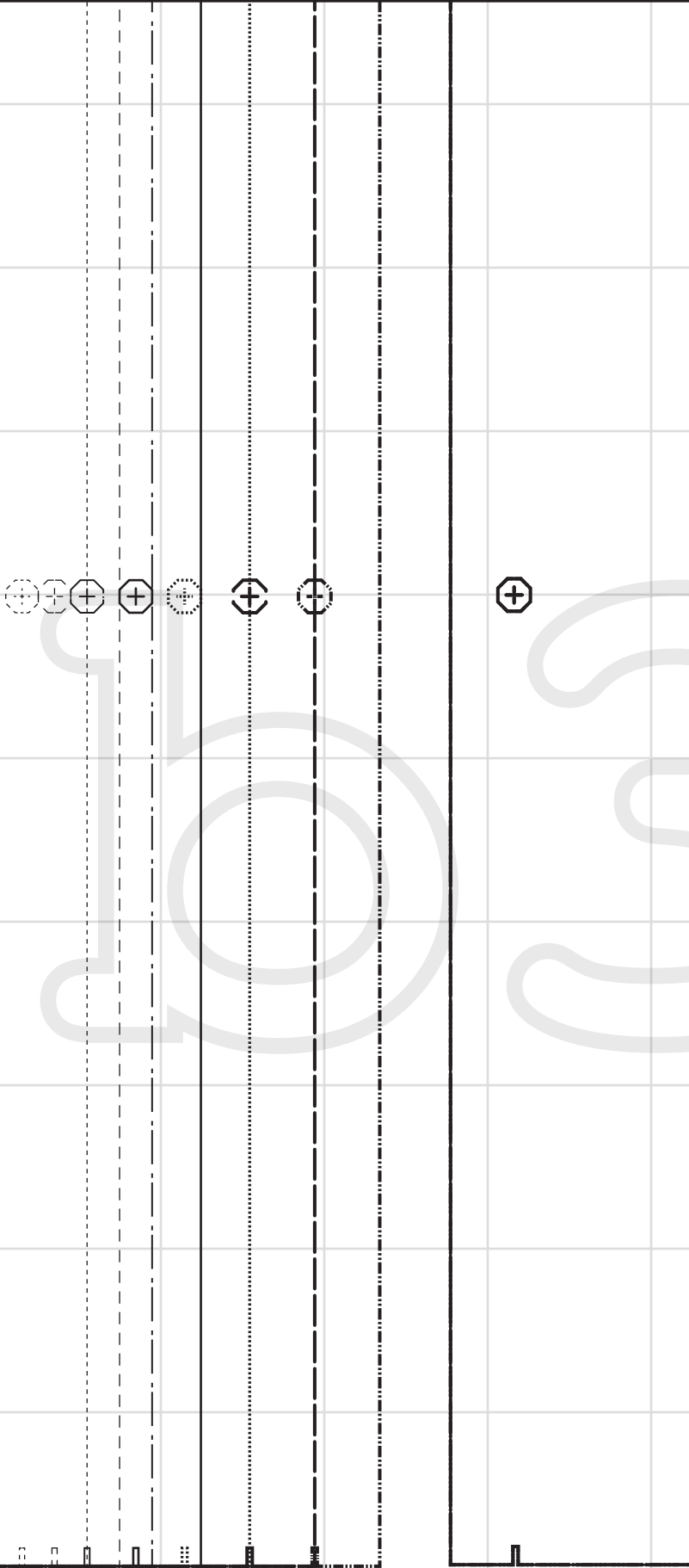

Grainline

SIZE KEY

XXL	-----
XL	-----
L	-----
M	-----
S	-----
XS	-----
XXS	-----

Cut on this line

Hem allowa

Cut on this line

ance 3 cm

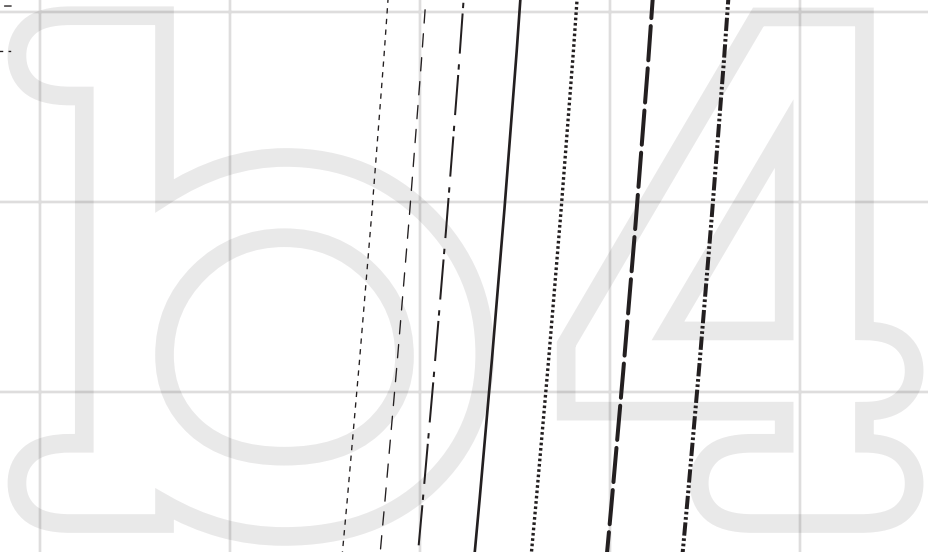

Cut on this line

Cut on this line

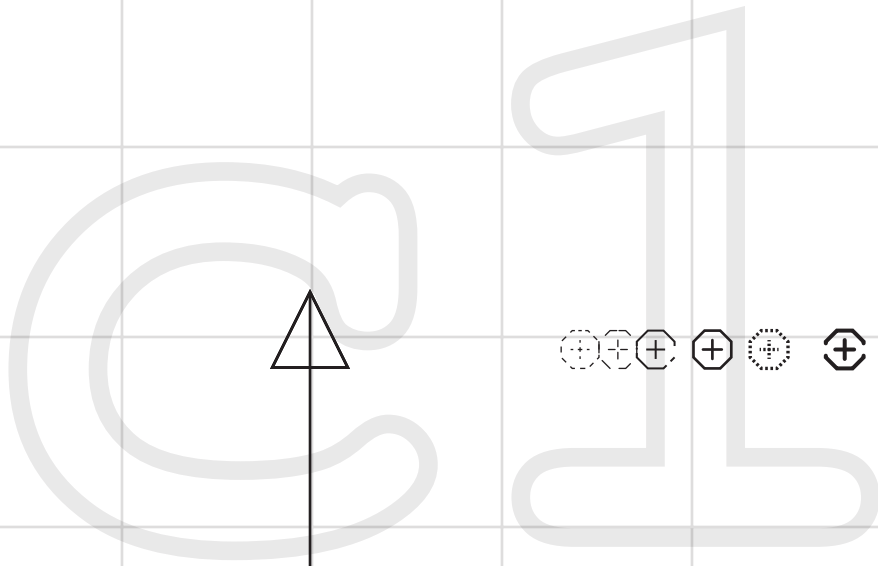

*unfettered*  
— unfettered patterns —

[unfetteredpatterns.wordpress.com](http://unfetteredpatterns.wordpress.com)

Model #UP1008

Sizes **XXS-XXL**

**Back**

Cut x2 fabric

Cut on this line

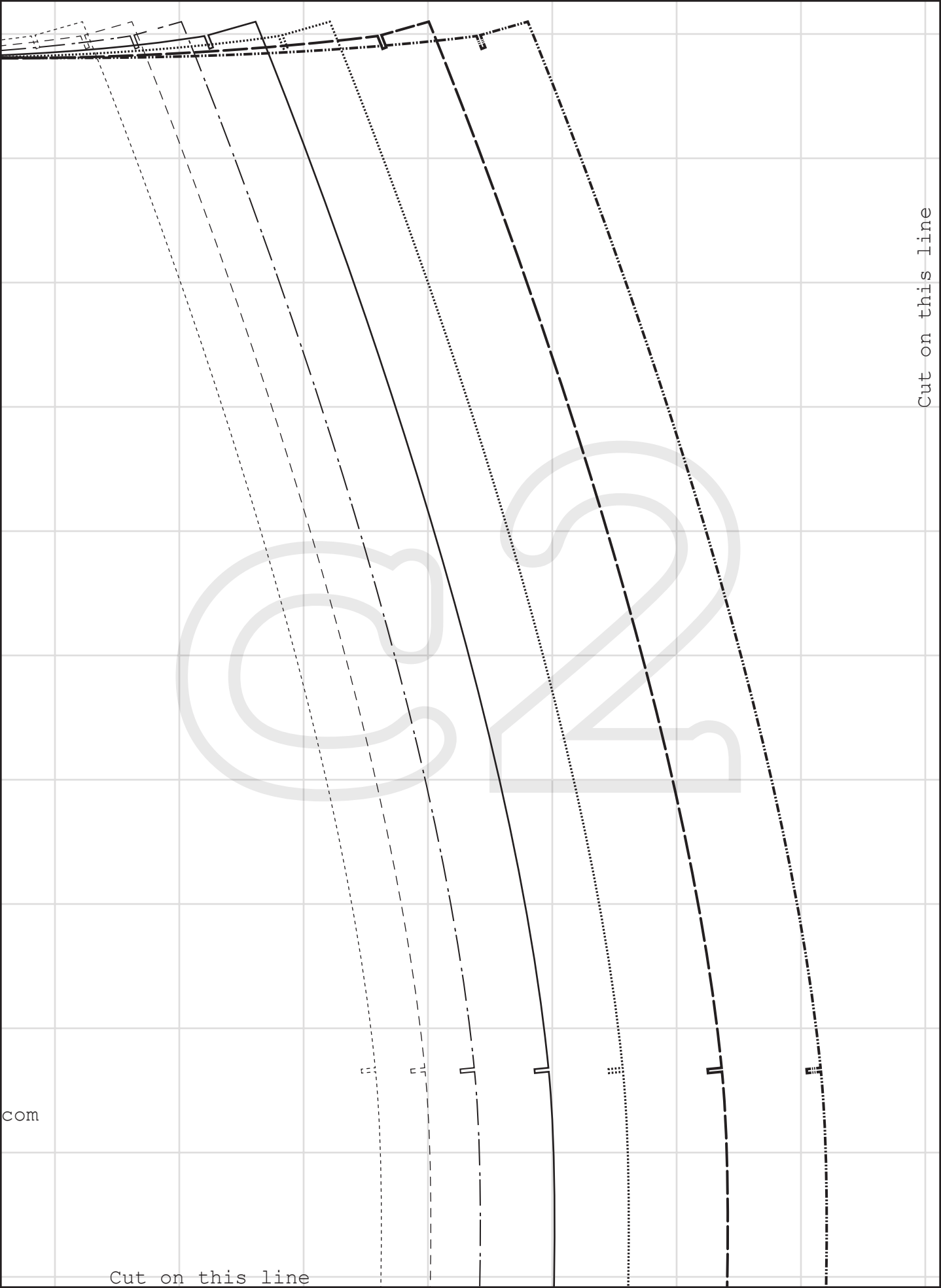

Cut on this line

com

Cut on this line

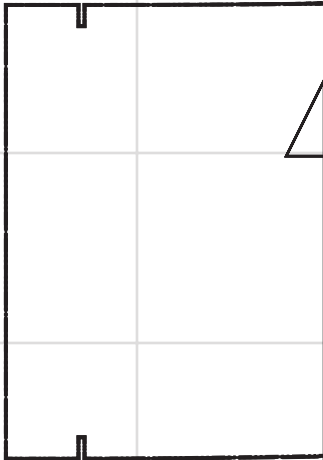

[unfetteredpatterns.wordpress.com](http://unfetteredpatterns.wordpress.com)

Model **#UP1008**

Sizes **XXS-XXL**

**Back facing**

Cut x2 fabric

Cut x2 interfacing

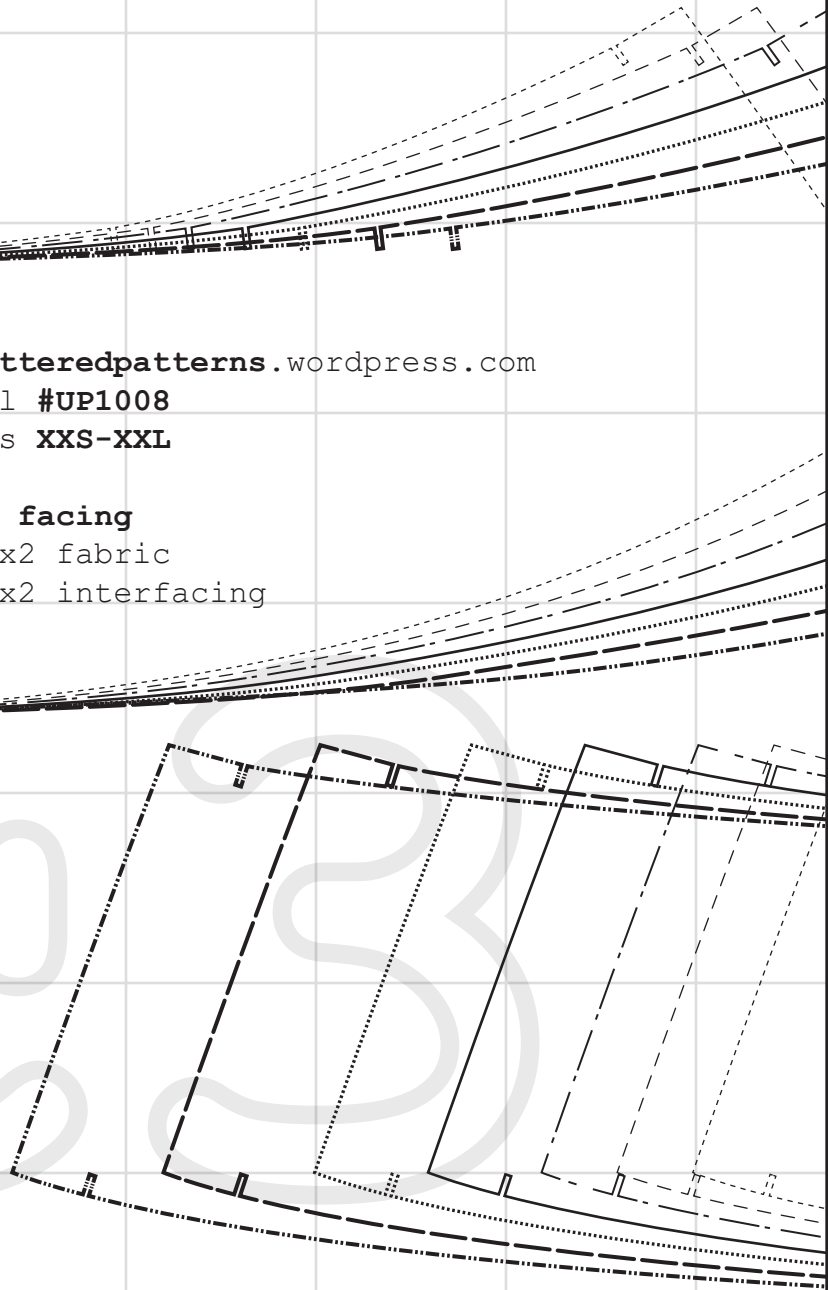

Cut on this line

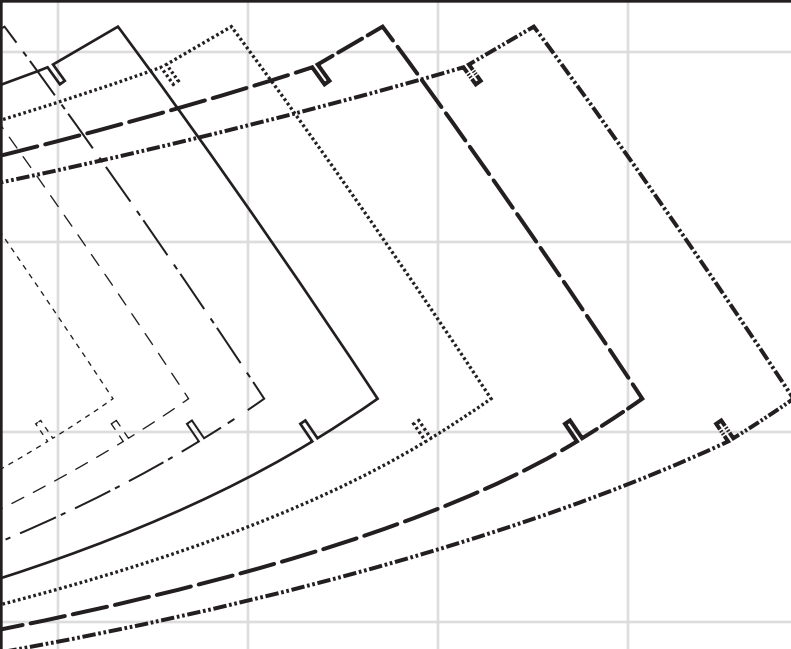

[unfetteredpatterns.wordpress.com](http://unfetteredpatterns.wordpress.com)

Model **#UP1008**

Sizes **XXS-XXL**

**Front facing**

Cut x1 fabric

Cut x1 interfacing

Grainline

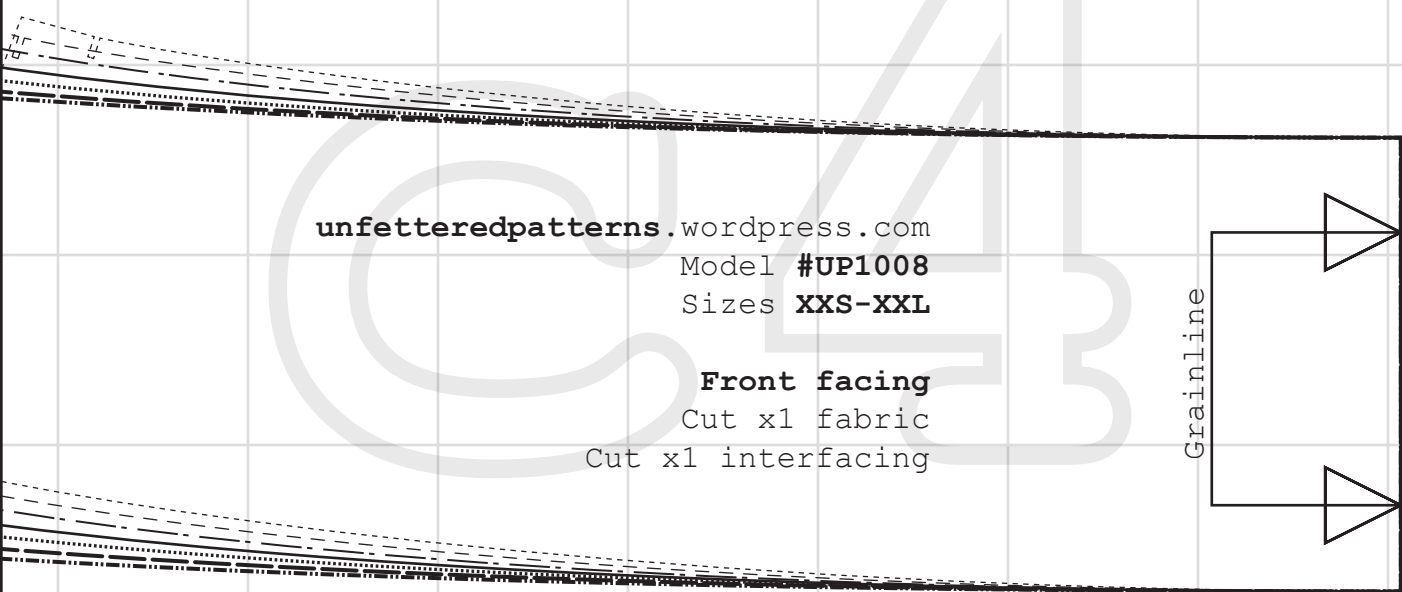
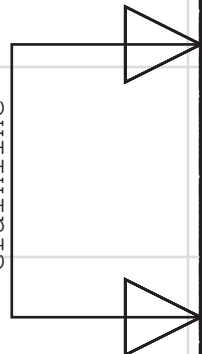

Grainline

SIZE KEY

XXL

XL

L

M

S

XS

XXS

Cut on this line

Hem allowance 3 cm

